



JA110 Dome

PREASSEMBLED & DIY KIT



Weight
1200kg Preassembled
510kg DIY

Whats Included

- Cement/Clay Oven
- Flue
- Steel Slab Base (Preassembled only)
- Steel Sub Floor
- 1 Pizza Paddle
- Refractory Brick Floor
- 1 Recipe Book
- 1 Powder Coated Oven Door
- 1 Oven Stand (Preassembled only)
- Assembly Instructions (DIY only)

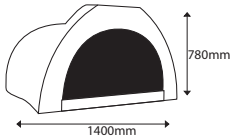

Oven Dimensions

External dimensions of oven

Length (front to back)	1500mm
Width (left to right)	1400mm
Oven Height (Excluding flue)	780mm
Weight (Preassembled)	1200kg
Weight (DIY)	510kg

Internal dimensions of oven

Length (front to back)	1330mm
Width (left to right)	1112mm

Flue details

Flue Height	1000mm
Flue Diameter	150mm
Flue Diameter Cap	275mm



Delivery Quote

For delivery quote go online
[jalandopizzaovens.com.au/
quotation-on-delivery](http://jalandopizzaovens.com.au/quotation-on-delivery)
0418 339 881 | 0438 783 533
Monday - Friday
10am to 4pm

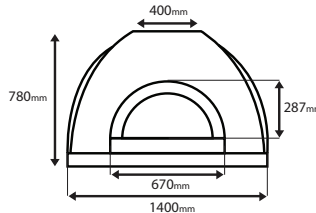

Oven Diagram (Front)

Width	1400mm
Height	780mm
Outer Arch Width	670mm
Outer Arch Height	287mm
Flue Base Width	400mm

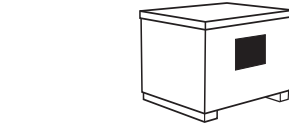

Box Dimensions

Preassembled oven

(L) 1550mm x (W) 1650mm x (H) 1080mm

DIY kit

(L) 1110mm x (W) 1170mm x (H) 1025mm

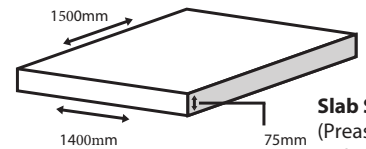

Slab Size
(Preassembled Only)

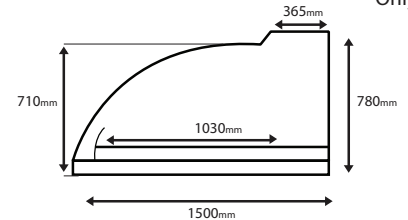

Oven Diagram (Side)

Length	1500mm
Height	780mm
Internal Cooking Area Length	1030mm
Internal Cooking Area Width	1112mm
Flue Base width	365mm
Rear Height	710mm

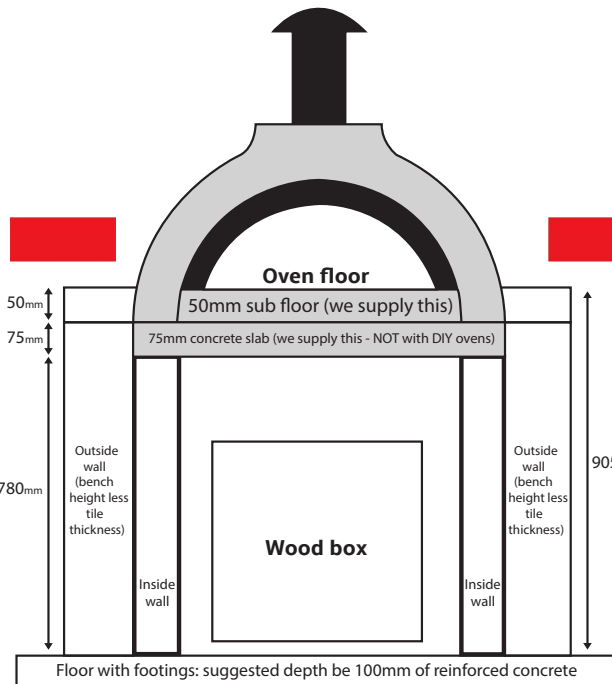

Oven sub floor	50mm
Slab	75mm
Sub floor and slab	125mm
Bench height	905mm +/-
Supporting wall for oven	780mm +/-
Oven floor height on supporting wall	905mm +/-

Note: Exterior wall height to suit tile and granite thickness to match oven floor height.

Suggested base sizes (plain base)

Length (including prep area)	1750mm
Front prep area	250mm
Width (suggested minimum)	1600mm
Width (with side prep area)	1900mm

Wood box (suggested)
600mm x 60mm x 800mm deep
Height (bench height)
905mm to 950mm

Suggested base sizes (corner base)

Sides (absolute minimum)	1900mm
Sides (good)	1950mm
Sides (recommended)	2000mm
Width of wall	1000mm
Front prep area (widest point)	250mm

Wood box (suggested)
600mm x 60mm x 800mm deep
Height (bench height)
850mm to 950mm
Distance from back corner
to front of oven floor

1830mm

Plain Base

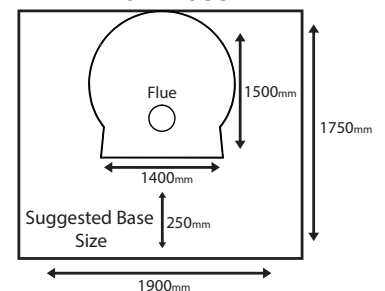

Corner base

